

INSTALLATION GUIDE

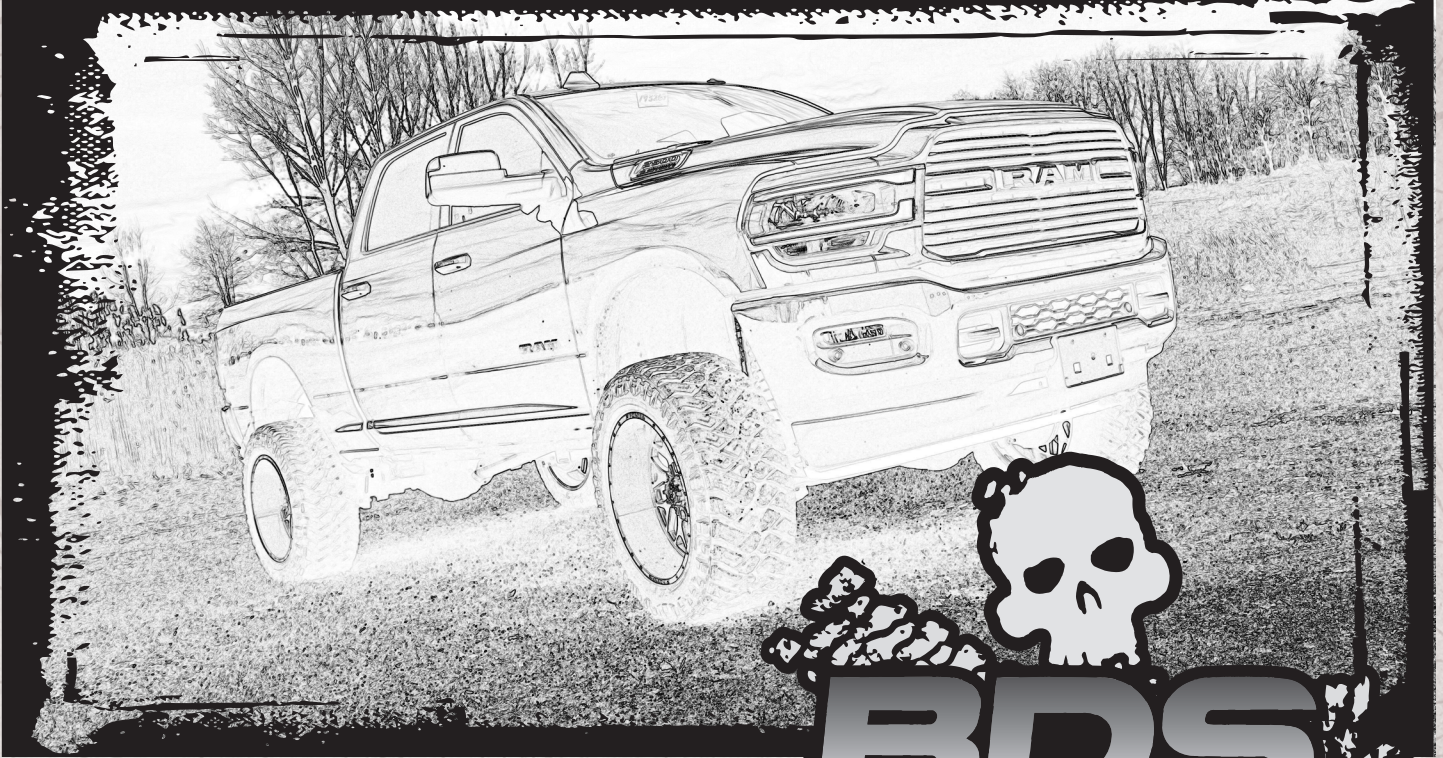

Part#: 012269



HARDCORE LIMITED LIFETIME WARRANTY

2.5" Rear Coil Spring

Dodge 2500 Pickup | 2019-2021

Rev. 022522

491 W. Garfield Ave., Coldwater, MI 49036 • Phone: 517-279-2135

Web: www.bds-suspension.com • E-mail: tech-bds@ridefox.com

Read And Understand All Instructions And Warnings Prior To Installation Of System And Operation Of Vehicle.

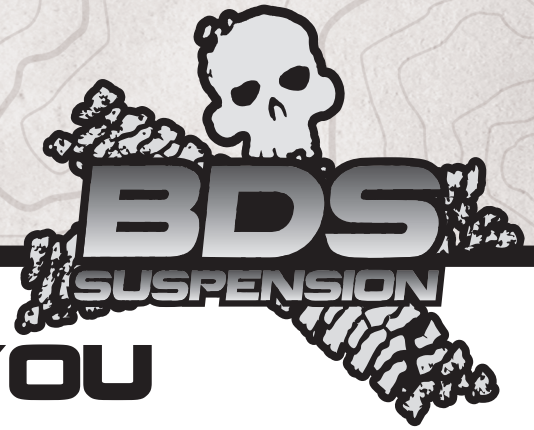

THANK YOU

Your truck is about to be fitted with the best suspension system on the market today. That means you will be driving the baddest looking truck in the neighborhood, and you'll have the warranty to ensure that it stays that way for years to come. Thank you for choosing BDS Suspension!

BEFORE YOU START

BDS Suspension Co. recommends this system be installed by a professional technician. In addition to these instructions, professional knowledge of disassembly/ reassembly procedures and post installation checks must be known.

FOR YOUR SAFETY

Certain BDS Suspension products are intended to improve off-road performance. Modifying your vehicle for off-road use may result in the vehicle handling differently than a factory equipped vehicle. Extreme care must be used to prevent loss of control or vehicle rollover. Failure to drive your modified vehicle safely may result in serious injury or death. BDS Suspension Co. does not recommend the combined use of suspension lifts, body lifts, or other lifting devices. You should never operate your modified vehicle under the influence of alcohol or drugs. Always drive your modified vehicle at reduced speeds to ensure your ability to control your vehicle under all driving conditions. Always wear your seat belt.

BEFORE INSTALLATION

Special literature required: OE Service Manual for model/year of vehicle. Refer to manual for proper disassembly/reassembly procedures of OE and related components.

Adhere to recommendations when replacement fasteners, retainers and keepers are called out in the OE manual.

Larger rim and tire combinations may increase leverage on suspension, steering, and related components. When selecting combinations larger than OE, consider the additional stress you could be inducing on the OE and related components.

Post suspension system vehicles may experience drive line vibrations. Angles may require tuning, slider on shaft may require replacement, shafts may need to be lengthened or trued, and U-joints may need to be replaced.

Secure and properly block vehicle prior to installation of BDS Suspension components. Always wear safety glasses when using power tools.

If installation is to be performed without a hoist, BDS Suspension Co. recommends rear alterations first.

Due to payload options and initial ride height variances, the amount of lift is a base figure. Final ride height dimensions may vary in accordance to original vehicle attitude. Always measure the attitude prior to beginning installation.



Visit 560plus.com for more information.

BEFORE YOU DRIVE

Check all fasteners for proper torque. Check to ensure for adequate clearance between all rotating, mobile, fixed, and heated members. Verify clearance between exhaust and brake lines, fuel lines, fuel tank, floor boards and wiring harness. Check steering gear for clearance. Test and inspect brake system.

Perform steering sweep to ensure front brake hoses have adequate slack and do not contact any rotating, mobile or heated members. Inspect rear brake hoses at full extension for adequate slack. Failure to perform hose check/ replacement may result in component failure. Longer replacement hoses, if needed can be purchased from a local parts supplier.

Perform head light check and adjustment.

Re-torque all fasteners after 500 miles. Always inspect fasteners and components during routine servicing.

CONTENTS OF YOUR KIT

| Coil Spring Box Kit: 012269 | | |
|------------------------------------|------------|--|
| <i>Part #</i> | <i>Qty</i> | <i>Description</i> |
| 03857 | 1 | Rear Track Bar Bracket |
| 145 | 1 | Track Bar Bracket Sleeve (2-1/8" long) |
| 032209 | 2 | 2.5" Rear Coil Spring |
| 02499 | 2 | Rear Bump Stop |
| 911112 | 2 | 15" Sway Bar Link |
| SB58BK | 4 | Hourglass Bushing - EB1 |
| 62147 | 4 | 5/8" x 12mm ID x 1-.3/8" Sleeve |
| 498 | 1 | Bolt Pack |
| | 1 | 9/16"-12 x 4" Bolt, Yellow Zinc |
| | 2 | 9/16" SAE Washer, Yellow Zinc |
| | 1 | 9/16"-12 Prevailing Torque Nut, Yellow Zinc |
| | 2 | 7/16"-14 x 1-1/2" Bolt, Yellow Zinc |
| | 2 | 7/16" SAE Washer, Yellow Zinc |
| | 2 | 7/16"-14 Serrated Edge Flanged Nut, Clear Zinc |
| 795 | 1 | Bolt Pack |
| | 4 | 12mm-1.75 x 65mm Bolt, Clear Zinc |
| | 8 | 7/16" USS Washer, Clear Zinc |
| | 4 | 12mm-1.75 Prevailing Torque Nut, Clear Zinc |
| 451 | 1 | Bolt Pack |
| | 4 | 10mm-1.50 x 80mm Bolt, Clear Zinc |
| | 4 | 10mm Washer, Clear Zinc |
| <i>Part #</i> | <i>Qty</i> | <i>Description</i> |
| 85757 | 2 | Rear NX2 Shocks |
| or | | |
| 98224753 | 2 | Rear Fox 2.0 Shocks |

INSTALLATION INSTRUCTIONS

INSTALLATION INSTRUCTIONS

1. Park vehicle on clean flat and level surface. Block front wheels for safety.
2. Disconnect the rear trackbar from the axle, retain all hardware. (Fig 1)

SPECIAL TOOLS

3/8", 1/2" Drill Bit

Tip: You may need to detach the vent hose clip from the track bar bracket to prevent the nut tab from puncturing the vent hose.

FIGURE 1



3. Raise rear of vehicle and support frame rails with jack stands.
4. Remove the rear wheels.
5. Support the rear axle with a hydraulic jack.
6. Disconnect the rear sway bar links from the frame and sway bar. (Fig 2)

FIGURE 2

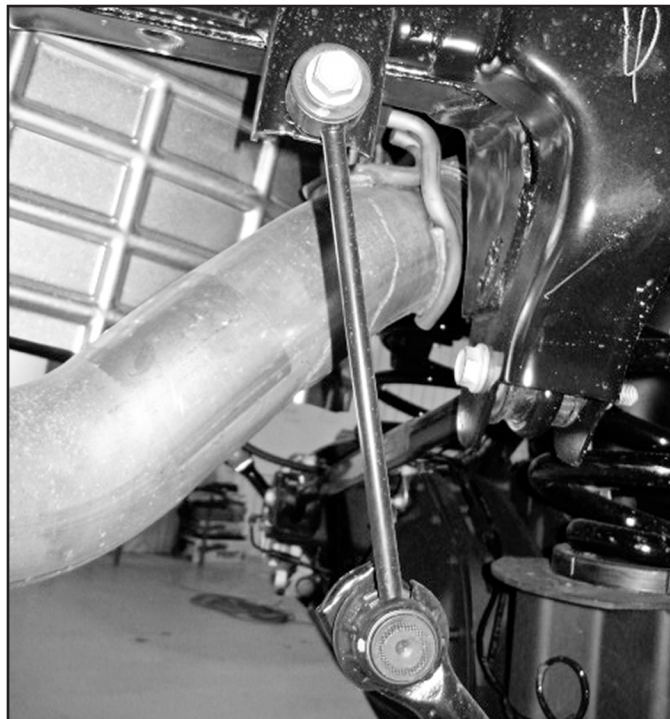

7. Disconnect the rear shocks and lower the axle, retain hardware. On the driver's side it is easiest to access the top hardware by cutting the inner fender well as shown. This trim procedure is not required but greatly aids in removal and installation of the shock. (Fig 3a, 3b)

FIGURE 3A



FIGURE 3B



8. Remove the rear coil springs and upper and lower coil spring retainers.
9. Disconnect the brake line bracket from the rear differential cover.

FIGURE 4



10. Install new coil springs with OEM isolators. The new coil springs will require the transfer of the plastic wrap from the factory coils to the new coils. The plastic spring wrap will eliminate any possible noise from the progressive coils. Raise axle and ensure that the isolators are centered over the factory mounts. Orientate the coils so that the lower locating tab is at the rear of the vehicle. (Fig 5)

FIGURE 5

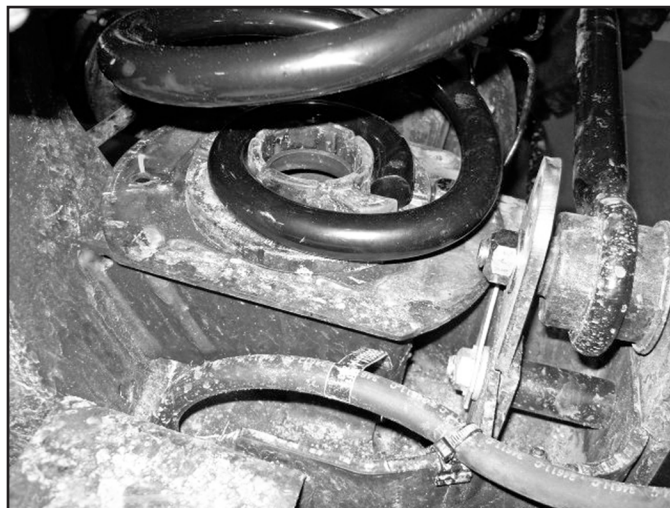

11. Clearance the bottom two holes in the factory track bar bracket with a 1/2" drill bit to accept 7/16" hardware.
12. Install the trackbar bracket to the axle. Hardware is located in bolt pack 498.. Place the 2-1/8" long sleeve and place it inside the track bar bracket at the factory track bar bolt location using the factory track bar bolt and nut tab. Using the 7/16" x 1-1/2" bolts, washers, and flange nuts attach the bracket through the bottom holes. (Fig 6)

FIGURE 6A



FIGURE 6B

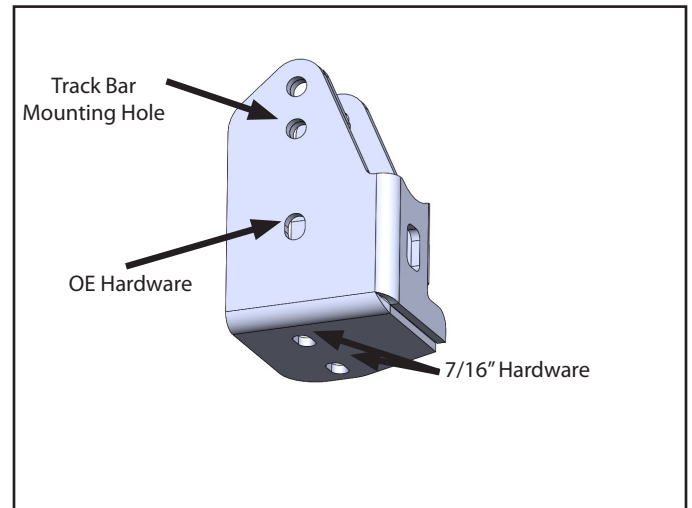

Note: It may be necessary to grind the top of the OE track bar rear mount flange due to vehicle variances.

13. Tighten the trackbar bracket hardware as follows: 14mm factory hardware to 140 ft-lbs, 7/16" hardware to 70 ft-lbs.
14. Drill out the small hole inside the frame behind the shock mounting hole to 3/8".
15. Install the shock eliminator bracket onto the shock using hardware in bolt pack 946 included in the shock box. Tighten 1/2" eliminator hardware to 75ft-lbs. Install the shocks into the vehicle. Tighten 3/4" eliminator hardware to 120ft-lbs (Fig 7)

FIGURE 7



16. Grease bushings and sleeves and install into the sway bar links. Install sway bar links with the new 12mm hardware. (BP 795). Tighten to 45 ft-lbs. (Fig 8)

FIGURE 8

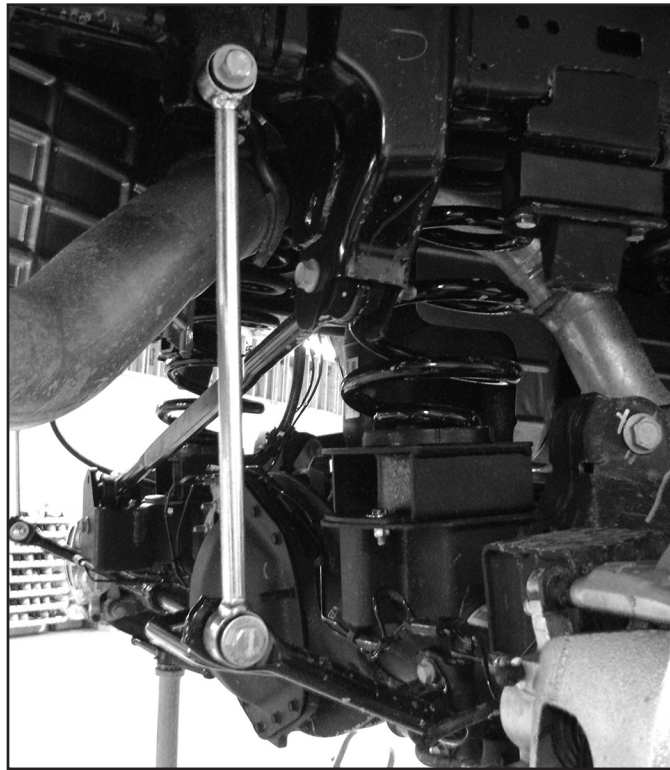

17. Remove the factory bump stops. Install bump stop drop brackets with new 10mm hardware (BP 796). Install so the small holes are towards the center of the vehicle. Tighten to 35 ft-lbs. (Fig 9a, 9b)

FIGURE 9A

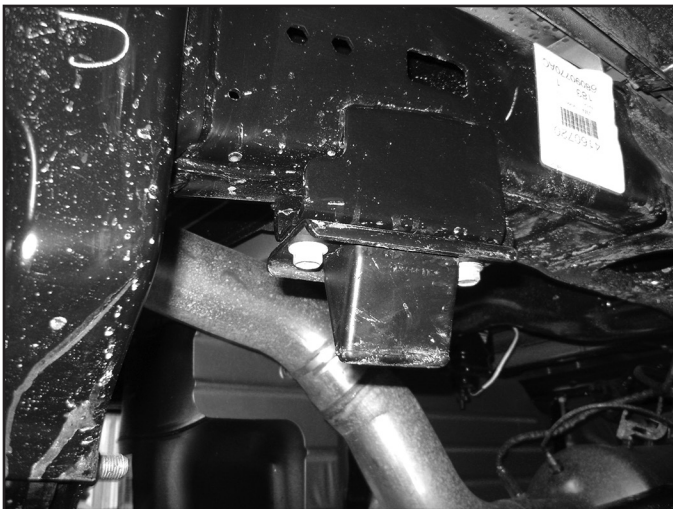
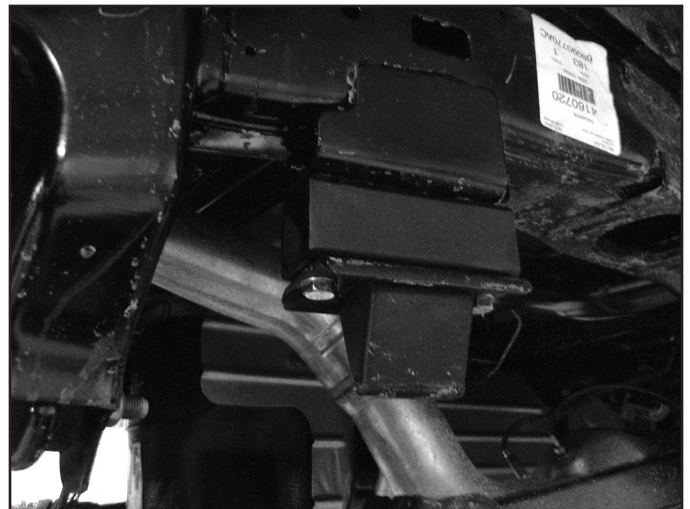

FIGURE 9B



18. Remount the rear brake line bracket to the rear diff with OE hardware.
19. Reinstall wheels, if installing aftermarket wheels it is recommended to remove all of the rotor retaining clips to allow the wheel to sit flush against the rotor. Tighten to factory specifications.
20. Lower vehicle to the ground.
21. Attach the trackbar to the new bracket with 9/16" x 4" hardware (BP 498) utilizing the bottom hole in the track bar bracket. It may be necessary to have an assistant push on one side of the truck slightly to get the holes aligned. Tighten to 154 ft-lbs.
22. Recheck all hardware for proper torque, check again after 500 miles.



WE WANT TO SEE YOUR RIDE!

Grab photos of your BDS-equipped truck in action and send them in for a chance to be featured. Send it in to our Bad Ass Rides customer gallery at bds-suspension.com/bar and post them on the BDS Fan Page on Facebook at facebook.com/BDSSuspensions. Don't forget about your BDS swag! BDS offers t-shirts, hoodies, decals and more available on the BDS website or through your local BDS distributor.

TIME TO HAVE SOME FUN

Thank you for choosing BDS Suspension.

For questions, technical support and warranty issues relating to this BDS Suspension product, please contact your distributor/installer before contacting BDS Suspension directly.