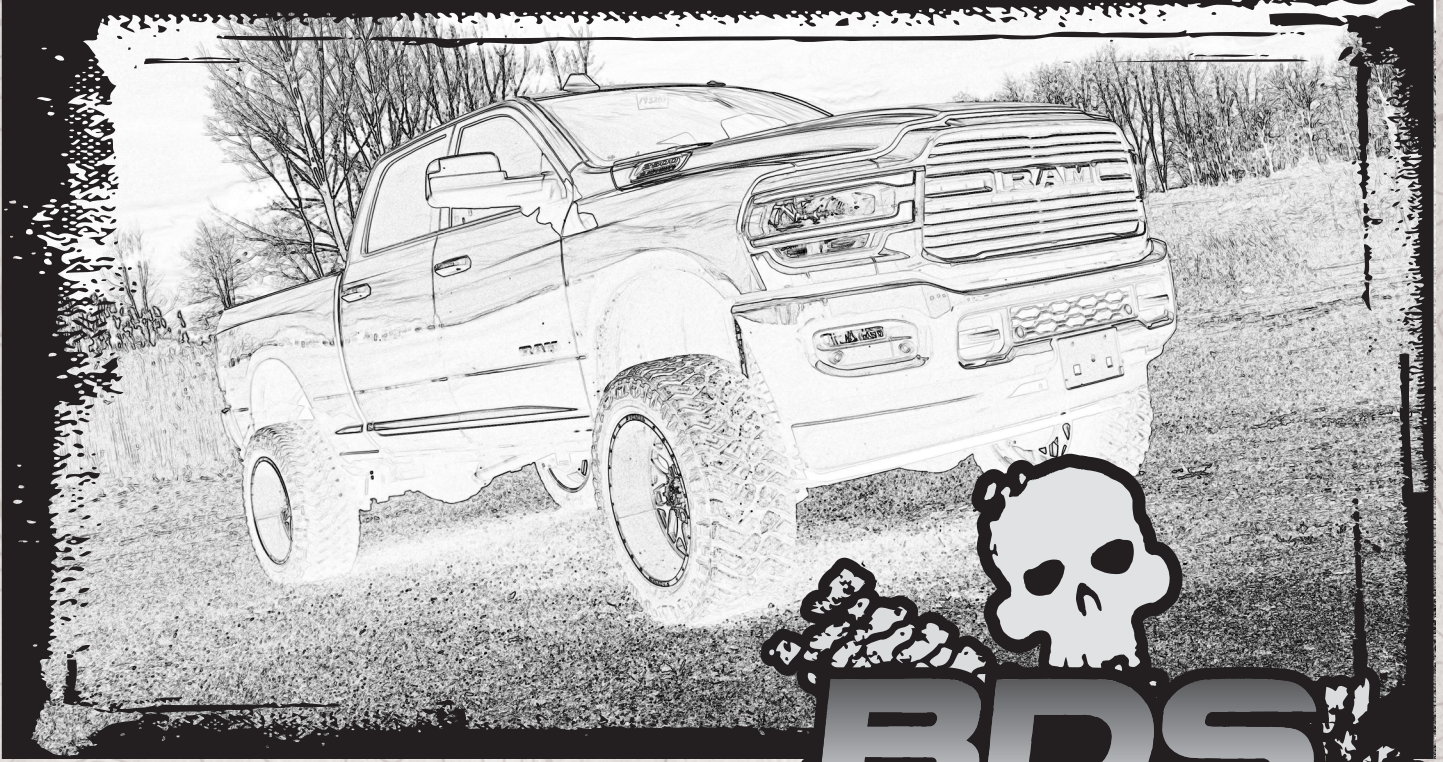


INSTALLATION GUIDE



Part#: 012358, 012528

HARDCORE LIMITED LIFETIME WARRANTY

3.5" & 5" Rear Air Ride Lift Systems

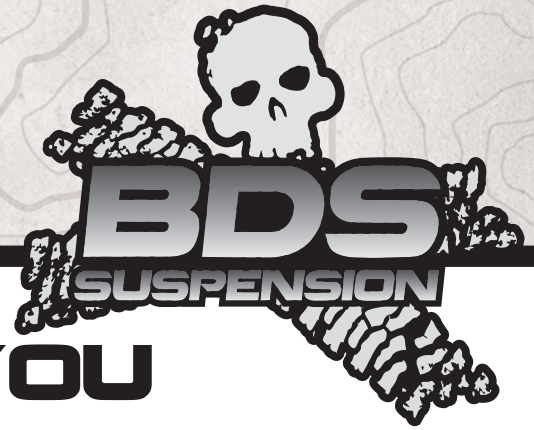
Dodge 2500 Pickup | 2019-21

Rev. 051121

491 W. Garfield Ave., Coldwater, MI 49036 • Phone: 517-279-2135

Web: www.bds-suspension.com • E-mail: tech-bds@ridefox.com

Read And Understand All Instructions And Warnings Prior To Installation Of System And Operation Of Vehicle.



THANK YOU

Your truck is about to be fitted with the best suspension system on the market today. That means you will be driving the baddest looking truck in the neighborhood, and you'll have the warranty to ensure that it stays that way for years to come. Thank you for choosing BDS Suspension!

BEFORE YOU START

BDS Suspension Co. recommends this system be installed by a professional technician. In addition to these instructions, professional knowledge of disassembly/ reassembly procedures and post installation checks must be known.

FOR YOUR SAFETY

Certain BDS Suspension products are intended to improve off-road performance. Modifying your vehicle for off-road use may result in the vehicle handling differently than a factory equipped vehicle. Extreme care must be used to prevent loss of control or vehicle rollover. Failure to drive your modified vehicle safely may result in serious injury or death. BDS Suspension Co. does not recommend the combined use of suspension lifts, body lifts, or other lifting devices. You should never operate your modified vehicle under the influence of alcohol or drugs. Always drive your modified vehicle at reduced speeds to ensure your ability to control your vehicle under all driving conditions. Always wear your seat belt.

BEFORE INSTALLATION

Special literature required: OE Service Manual for model/year of vehicle. Refer to manual for proper disassembly/reassembly procedures of OE and related components.

Adhere to recommendations when replacement fasteners, retainers and keepers are called out in the OE manual.

Larger rim and tire combinations may increase leverage on suspension, steering, and related components. When selecting combinations larger than OE, consider the additional stress you could be inducing on the OE and related components.

Post suspension system vehicles may experience drive line vibrations. Angles may require tuning, slider on shaft may require replacement, shafts may need to be lengthened or trued, and U-joints may need to be replaced.

Secure and properly block vehicle prior to installation of BDS Suspension components. Always wear safety glasses when using power tools.

If installation is to be performed without a hoist, BDS Suspension Co. recommends rear alterations first.

Due to payload options and initial ride height variances, the amount of lift is a base figure. Final ride height dimensions may vary in accordance to original vehicle attitude. Always measure the attitude prior to beginning installation.



Visit 560plus.com for more information.

BEFORE YOU DRIVE

Check all fasteners for proper torque. Check to ensure for adequate clearance between all rotating, mobile, fixed, and heated members. Verify clearance between exhaust and brake lines, fuel lines, fuel tank, floor boards and wiring harness. Check steering gear for clearance. Test and inspect brake system.

Perform steering sweep to ensure front brake hoses have adequate slack and do not contact any rotating, mobile or heated members. Inspect rear brake hoses at full extension for adequate slack. Failure to perform hose check/ replacement may result in component failure. Longer replacement hoses, if needed can be purchased from a local parts supplier.

Perform head light check and adjustment.

Re-torque all fasteners after 500 miles. Always inspect fasteners and components during routine servicing.

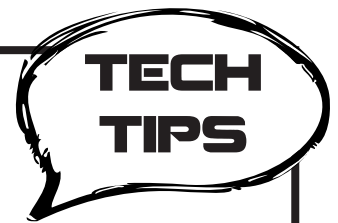
CONTENTS OF YOUR KIT

Rear Air Bag Spacer Box Kit (012358, 012528)		
Part #	Qty	Description
03857	1	19 Ram 2500 Rear Track Bar Bracket
02964	2	5in Air Bag Spacer (012528 only)
02963	2	3.5 in Air Bag Spacer (012358 only)
02961	1	Air Ride Sensor Brkt - Drv
02962	1	Air Ride Sensor Brkt - Pass
02965	2	Bump Stop Extension
911112	2	09 Dodge Sway Bar Link
145	1	1.00 x 0.120 x 2.125 DOM Sleeve
03896	1	2019 Ram Rear Brake Bracket (012528 only)
01661	2	Fuel Line Relocation Bracket (012528 only)
03819	3	1.00 x .3125 x .602 DOM Sleeve
SB58BK	4	5/8 ID Hourglass Bushing - black
354	1	Bolt Pack - Ram 2500/3500 Rear Brake Line (012528 only)
	2	3/8"-16 x 1-1/4" Bolt, Grade 8, Yellow Zinc
	4	3/8" SAE Washer, Yellow Zinc
	2	3/8"-16 Prevailing Torque Nut, Yellow Zinc
356	1	Bolt Pack - Ram 2500 Brake Brackets (012528 only)
	2	5/16"-18 x 1" Bolt, Clear Zinc
	4	5/16" SAE Washer, Clear Zinc
	2	5/16"-18 Prevailing Torque Nut, Clear Zinc
	1	8mm-1.25 Prevailing Torque Nut, Clear Zinc
	1	1/4" USS Washer, Clear Zinc

Rear Air Bag Spacer Box Kit (012358, 012528)		
355	1	Bolt Pack - Ram 2500 Air Tank
	3	8mm-1.25 x 50mm Bolt, Clear Zinc
	3	5/16" SAE flat washer, Clear Zinc
458	1	Bolt Pack
	8	10mm-1.50 x 25mm Bolt, Clear Zinc
	4	10mm-1.5- Prevailing Torque Nut, Clear Zinc
	12	10mm Washer, Clear Zinc
498	1	Bolt Pack
	1	9/16"-12 x 4" Bolt, Yellow Zinc
	2	9/16" SAE Washer, Yellow Zinc
	1	9/16"-12 Prevailing Torque Nut, Yellow Zinc
	2	7/16"-14 x 1-1/2" Bolt, Yellow Zinc
	2	7/16" SAE Washer, Yellow Zinc
	2	7/16"-14 Serrated Edge Flanged Nut, Clear Zinc
359	1	Bolt Pack
	2	6mm-1.00 Nylock Nut, Clear Zinc
	2	6mm-1.00 x 20mm Bolt, Clear Zinc
	2	6mm Washer, Clear Zinc
	2	3/8-16 x 1" Self Tapping Bolt, Clear Zinc
	4	3/8"-16 x 1" Bolt, Yellow Zinc
	4	3/8"-16 Prevailing Torque Nut, Yellow Zinc
	8	3/8" SAE Washer, Yellow Zinc
	1	8mm-1.25 Nylock Nut, Clear Zinc
	1	8mm Washer, Clear Zinc
795	1	Bolt Pack
	4	12mm-1.75 x 65mm Bolt, Clear Zinc
	8	7/16" USS Washer, Clear Zinc
	4	12mm-1.75 Prevailing Torque Nut, Clear Zinc

TROUBLESHOOTING INFORMATION FOR YOUR VEHICLE

1. When installing this rear air ride system in conjunction with a 4-Link system. Use the provided air tank spacers in this box kit to provide clearance to the brackets.



INSTALLATION INSTRUCTIONS

1. Park vehicle on clean flat and level surface. Block front wheels for safety.
2. Disconnect the battery to disable the rear air suspension.
3. Disconnect the rear trackbar from the axle, retain all hardware. (Fig 1)

SPECIAL TOOLS

1/2", 3/8" Drill Bit



Tip

You may need to detach the vent hose clip from the track bar bracket to prevent the nut tab from puncturing the vent hose.

FIGURE 1



4. Raise the rear of the vehicle and support the frame rails with jack stands.
5. Remove the rear wheels.
6. Support the rear axle with a hydraulic jack.
7. Remove the rear brake line bracket from the rear axle for extra slack during installation, and from the passenger side of the rear differential (Fig 2), save hardware.

FIGURE 2



8. Remove E-brake bracket from the driver side frame in the wheel wheel for extra slack during installation, save hardware. (Fig 3)

FIGURE 3



9. Disconnect the rear sway bar links from the frame and sway bar. (Fig 4A,4B)



Tip

Once the nut is loose on the sway bar, use a 8mm socket to tighten the stud and hold the nut with an 18mm wrench as shown in Fig 4B

FIGURE 4A



FIGURE 4B



10. Loosen the air fittings at the valve block on the passenger side frame rail to allow the air to bleed from the rear bags (Fig 5A).
11. Disconnect the ride height linkage from the axle using a clip tool (Fig 5B).

FIGURE 5A

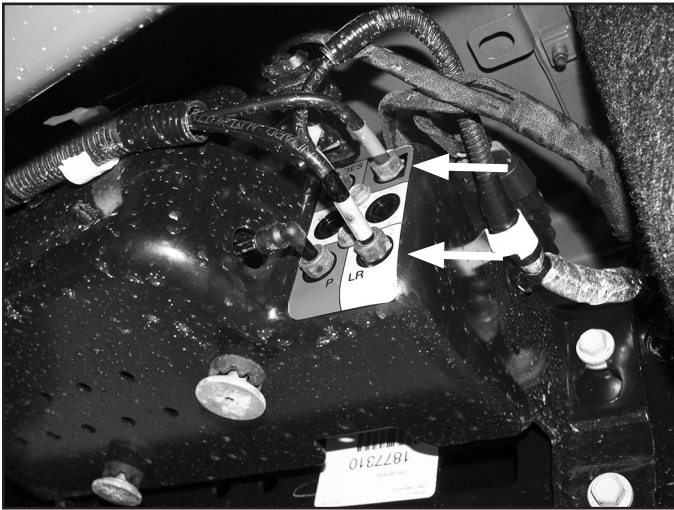


FIGURE 5B



12. Disconnect the rear shocks and lower the axle, retain hardware. On the driver's side it is easiest to access the top hardware by cutting the inner fender well as shown. This trim procedure is not required but greatly aids in removal and installation of the shock (Fig 6, 7).



Tip

Tip: You may also remove the inner fender liner if you prefer not to cut and need easier access to the shock nut.

FIGURE 6



FIGURE 7

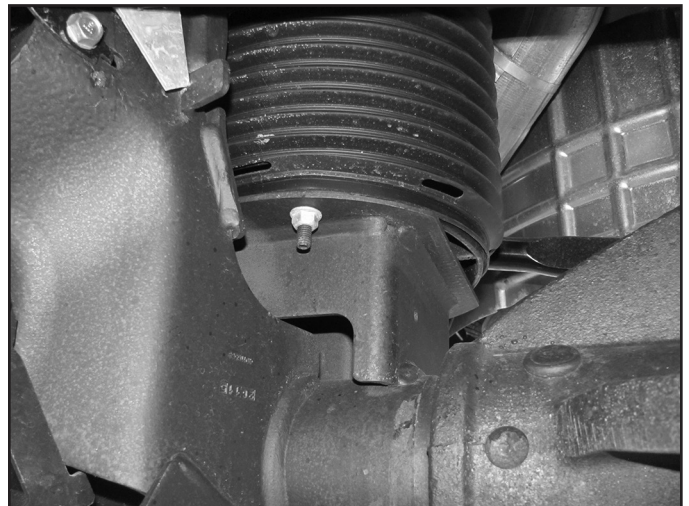


13. Remove the air bag to axle mounting nuts; 2 per side. Fig 8, 9)

FIGURE 8

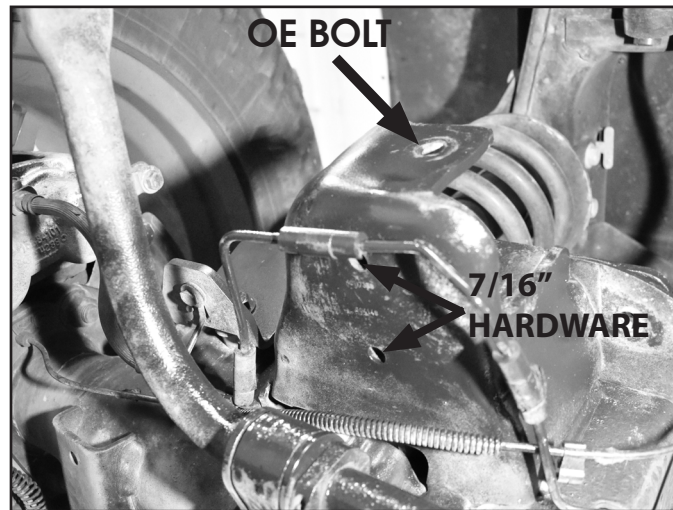


FIGURE 9



14. Install the rear air bag spacers with 3/8" hardware (BP 359). Tighten 3/8" hardware to 37 ft-lbs.
15. Clearance the bottom two holes in the factory track bar bracket with a 1/2" drill bit to accept 7/16" hardware. (Fig 10)
16. Install the trackbar bracket to the axle. Hardware is located in bolt pack 498.. Place the 2-1/8" long sleeve and place it inside the track bar bracket at the factory track bar bolt location using the factory track bar bolt and nut tab. Using the 7/16" x 1-1/2" bolts, washers, and flange nuts attach the bracket through the bottom holes. (Fig. 10)

FIGURE 10



Tip

It may be necessary to grind the top of the OE track bar rear mount flange due to vehicle variances.

17. Tighten the trackbar bracket hardware as follows: 14mm factory hardware to 140 ft-lbs, 7/16" hardware to 70 ft-lbs.
18. Attach the air bags to the air bag spacers using the factory nuts. An additional 8mm nut and washer is provided in bolt pack 359 if one is not installed from the factory on the driver's side. Torque to 14 ft-lbs (Fig 11)

FIGURE 11



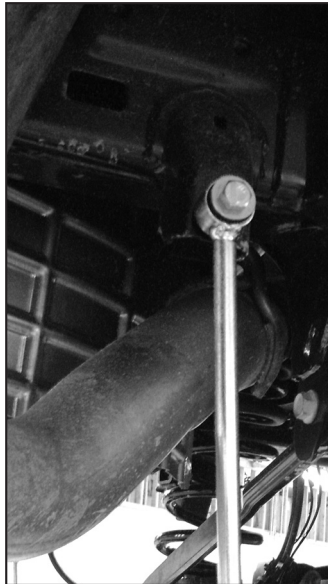
19. Install the shock eliminator bracket onto the shock using hardware in bolt pack 946 included in the shock box. Tighten 1/2" eliminator hardware to 75ft-lbs. Drill out the small hole inside the frame behind the shock mounting hole to 3/8". Install the shocks into the vehicle. Tighten 3/4" eliminator hardware to 120ft-lbs (Fig 12)

FIGURE 12



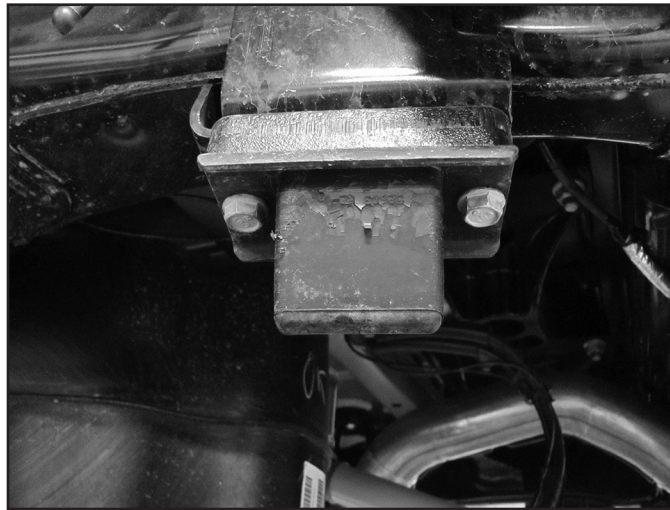
20. Grease the bushings and sleeves and install them into the sway bar links. Install the sway bar links with the new 12mm hardware. (BP 795). Tighten to 45 ft-lbs. (Fig 13)

FIGURE 13



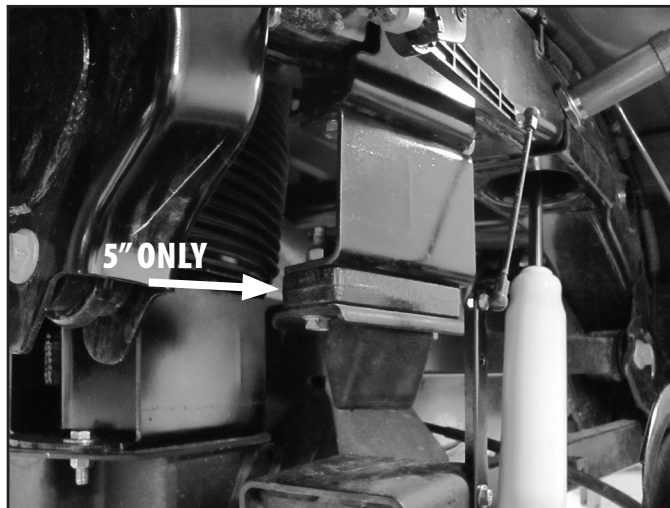
21. Remove the factory bump stops from the vehicle. (Fig 14)

FIGURE 14



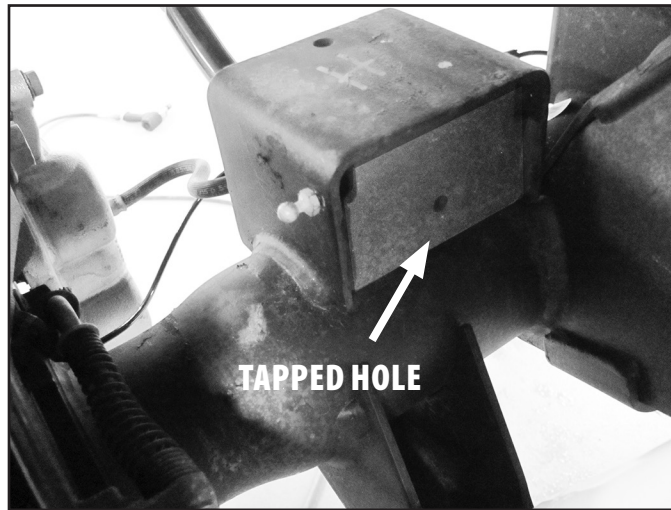
22. **3.5" Bump Stop Installation:** Install the bump stop drop brackets with the new 10mm hardware to the frame (BP 458). Install so the gusseted side faces in and offsets the bumpstop towards the center of the vehicle. Torque the 10mm hardware at the frame to 40 ft-lbs. Using the provided 10mm bolts, nuts, and washers, attached the bump stop directly to the bottom of the drop bracket. The factory spacer will not be used. Tighten to 45 ft-lbs. (Fig 15)
23. **5" Bump Stop Installation:** Install the bump stop drop brackets with the new 10mm hardware to the frame (BP 458). Install so the gusseted side faces in and offsets the bumpstop towards the center of the vehicle. Torque the 10mm hardware at the frame to 40 ft-lb. Using the stock bolts and provided nuts and washers, install the bump stop WITH the factory bump stop spacer to the bottom of the drop bracket. Tighten to 45 ft-lbs. (Fig 15)

FIGURE 15



24. Remove the ride height sensor linkage stud from the axle (Fig 16).
25. Using the supplied 3/8" self tapping bolt (BP359), thread the holes in front of the bump stop pads (Fig. 16).

FIGURE 16



26. Fasten the sensor relocation brackets to the axle with the 3/8" self tapping bolt and provided 6mm bolt and washer (BP 359) (Fig 17, 18)

FIGURE 17

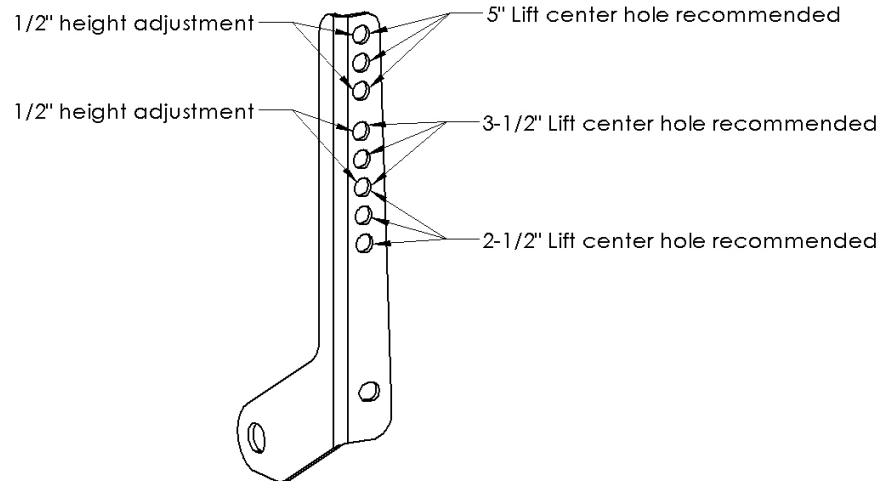


FIGURE 18



27. Attach the factory linkage stud to the linkage bracket with the provided nylock nut (BP359). Use the following image as a guide for your desired ride height. Pop the linkage rod back onto the stud. (Fig 19)

FIGURE 19



- 28. **3.5" Lift Only, Brake Lines:** Remount the rear axle hardlines to the factory location with the factory brackets and remount the e-brake cable to the factory location with the factory hardware. Torque to 15 ft-lbs.
- 29. **5" Lift Only Brake Line Brackets:** Install the rear axle brake line bracket utilizing factory hardware on the axle and 3/8" hardware from BP 354. (Fig 20). Then install the hard line relocation bracket on the passenger side of the differential cover using the 8mm nut and 1/4" washer on the axle and 5/16" hardware on the brakeline bracket.(BP 356) (Fig 21)

FIGURE 20

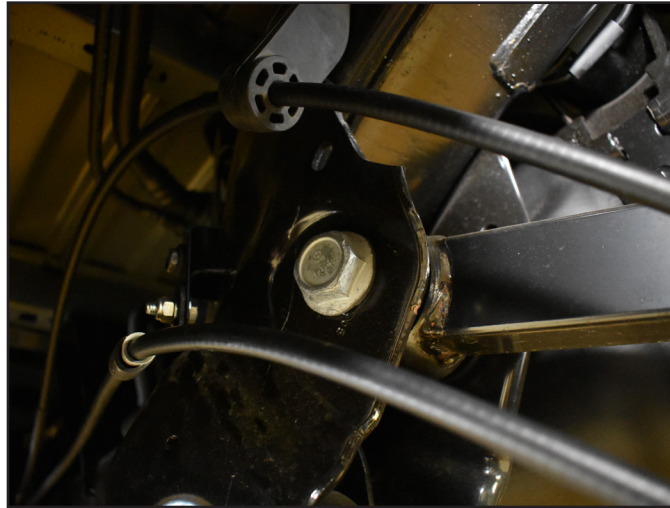


FIGURE 21



- 30. **5" Lift Only, E-Brake Line Brackets:** Install the driver side rear brake line bracket to reattach the e-brake to the frame. (Fig 22)

FIGURE 22



31. Reinstall wheels, if installing aftermarket wheels it is recommended to remove all of the rotor retaining clips to allow the wheel to sit flush against the rotor. Tighten to factory specifications.
32. Lower the vehicle to the ground. Ensure the air bags are seated correctly at the frame.
33. Tighten the air fittings at the valve block loosened in Figure 3. The torque spec is 53 in-lbs. Do not overtighten as this could lead to damage to the threads.
34. Cycle the key to the ignition on position until the rear air bags are inflated to the set ride height.
35. Attach the trackbar to the new bracket with 9/16" x 4" hardware (BP 498). It may be necessary to have an assistant push on one side of the truck slightly to get the holes aligned. Tighten to 130 ft-lbs. 2.5"-3.5" kits use the lower hole, 5" rear kits use the upper hole.
36. Recheck all hardware for proper torque, check again after 500 miles.

AIR TANK INSTALLATION:

37. If installing a lift with 4-link brackets. This box kit contains 3 air tank spacers (03819) and bolts to provide bracket clearance. Remove the 3 factory mounting bolts. Insert the spacers between the tank mounts and frame and tighten with the provided hardware (BP 355). Torque to 15 ft-lbs. (Fig 23)

FIGURE 23



WE WANT TO SEE YOUR RIDE!

Grab photos of your BDS-equipped truck in action and send them in for a chance to be featured. Send it in to our Bad Ass Rides customer gallery at bds-suspension.com/bar and post them on the BDS Fan Page on Facebook at facebook.com/BDSSuspensions. Don't forget about your BDS swag! BDS offers t-shirts, hoodies, decals and more available on the BDS website or through your local BDS distributor.

TIME TO HAVE SOME FUN

Thank you for choosing BDS Suspension.

For questions, technical support and warranty issues relating to this BDS Suspension product, please contact your distributor/installer before contacting BDS Suspension directly.