

# INSTALLATION GUIDE

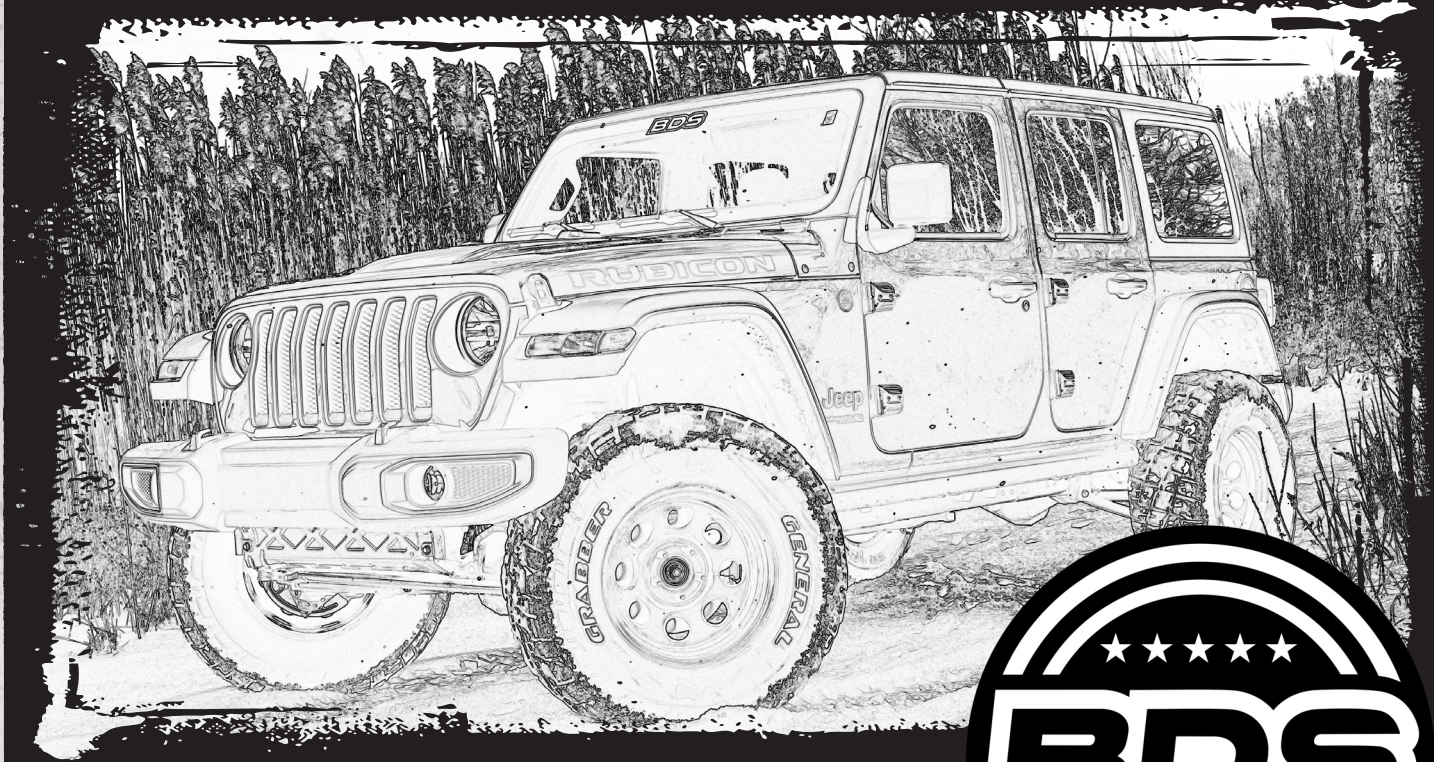

Part#: 014330



**HARDCORE LIMITED LIFETIME WARRANTY**

## 3" Suspension Lift Kit

Jeep Wrangler JL 4 Door 4WD | 2018-2024

Jeep Wrangler JL 2 Door 4WD | 2018-2024

491 W. Garfield Ave., Coldwater, MI 49036 • Phone: 517-279-2135

Web: [www.bds-suspension.com](http://www.bds-suspension.com) • E-mail: [tech-bds@ridefox.com](mailto:tech-bds@ridefox.com)

Rev. 091223

# Read And Understand All Instructions And Warnings Prior To Installation Of System And Operation Of Vehicle.

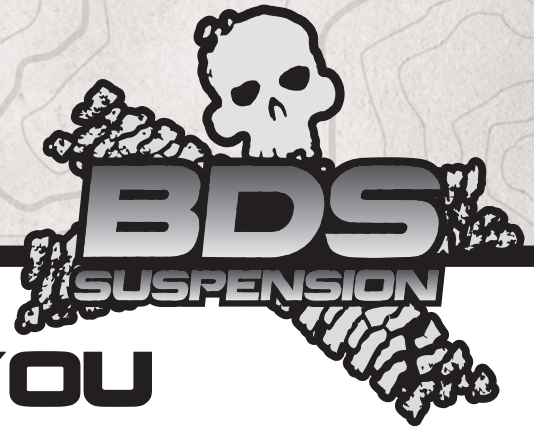

## THANK YOU

Your jeep is about to be fitted with the best suspension system on the market today. That means you will be driving the baddest looking truck in the neighborhood, and you'll have the warranty to ensure that it stays that way for years to come. Thank you for choosing BDS Suspension!

### BEFORE YOU START

BDS Suspension Co. recommends this system be installed by a professional technician. In addition to these instructions, professional knowledge of disassembly/ reassembly procedures and post installation checks must be known.

### FOR YOUR SAFETY

Certain BDS Suspension products are intended to improve off-road performance. Modifying your vehicle for off-road use may result in the vehicle handling differently than a factory equipped vehicle. Extreme care must be used to prevent loss of control or vehicle rollover. Failure to drive your modified vehicle safely may result in serious injury or death. BDS Suspension Co. does not recommend the combined use of suspension lifts, body lifts, or other lifting devices. You should never operate your modified vehicle under the influence of alcohol or drugs. Always drive your modified vehicle at reduced speeds to ensure your ability to control your vehicle under all driving conditions. Always wear your seat belt.

### BEFORE INSTALLATION

- Special literature required: OE Service Manual for model/year of vehicle. Refer to manual for proper disassembly/reassembly procedures of OE and related components.
- Adhere to recommendations when replacement fasteners, retainers and keepers are called out in the OE manual.
- Larger rim and tire combinations may increase leverage on suspension, steering, and related components. When selecting combinations larger than OE, consider the additional stress you could be inducing on the OE and related components.
- Post suspension system vehicles may experience drive line vibrations. Angles may require tuning, slider on shaft may require replacement, shafts may need to be lengthened or trued, and U-joints may need to be replaced.
- Secure and properly block vehicle prior to installation of BDS Suspension components. Always wear safety glasses when using power tools.
- If installation is to be performed without a hoist, BDS Suspension Co. recommends rear alterations first.
- Due to payload options and initial ride height variances, the amount of lift is a base figure. Final ride height dimensions may vary in accordance to original vehicle attitude. Always measure the attitude prior to beginning installation.



Visit [560plus.com](http://560plus.com) for more information.

### TRACTION CONTROL

In an effort to reduce the risk of rollover crashes the National Highway Traffic Safety Administration (NHTSA) established the Federal Motor Vehicle Safety Standard (FMVSS) No. 126 requiring all new passenger vehicles under 10,000 lbs GVWR include an electronic stability control (ESC) system as standard equipment. Effective August 2012 this law requires after-market products to be compliant with these same standards.



### TIRES AND WHEELS

#### FITMENT GUIDE

##### *Sport, Sport S, Sahara Models*

35x12.50 on 17x9 with 4.5" max backspacing for full bump tire clearance

37x12.50 on 17x9 with 4.5" max backspacing  
Rubbing can occur under full articulation

##### *Rubicon Models*

37x12.50 on 17x9 with 4.5" max backspacing for full bump tire clearance



### BEFORE YOU DRIVE

Check all fasteners for proper torque. Check to ensure for adequate clearance between all rotating, mobile, fixed, and heated members. Verify clearance between exhaust and brake lines, fuel lines, fuel tank, floor boards and wiring harness. Check steering gear for clearance. Test and inspect brake system.

Perform steering sweep to ensure front brake hoses have adequate slack and do not contact any rotating, mobile or heated members. Inspect rear brake hoses at full extension for adequate slack. Failure to perform hose check/replacement may result in component failure. Longer replacement hoses, if needed can be purchased from a local parts supplier.

Perform head light check and adjustment.

Re-torque all fasteners after 500 miles. Always inspect fasteners and components during routine servicing.

# CONTENTS OF YOUR KIT

## 034340 4-Door Box Kit

Part #	Qty	Description
034340R	2	Front Coil Springs

## 034346 4-Door Box Kit

Part #	Qty	Description
034346R	2	Rear Coil Springs

## 034240 2-Door Box Kit

Part #	Qty	Description
034240	2	Front Coil Springs

## 034246 2-Door Box Kit

Part #	Qty	Description
034246	2	Rear Coil Springs

## 014330 Box Kit

Part #	Qty	Description
3396	2	Front bump Stop Extension
03324	2	Rear Bump Stop Extension
03579	1	Track Bar Bracket
03580	1	Track Bar Bracket Support
911111	2	Rear Sway Bar Link
SB58BK	4	5/8 ID Hourglass Bushing
62147	4	.625 x .075 x 1.375 Sleeve
03315	1	JL Disconnect Retention Brkt - Drv 2.5-6"
03316	1	JL Disconnect Retention Brkt - Pass 2.5-6"
A1024	2	JKS Quicker Disconnect
03005	2	Quick Pin (2001CP)
M03212-BK-01	3	Offset Polyurethane Spacer
A1046	1	03013 Stud w/ nut
A1045	1	03017 Stud w/ nut
01499	1	1/4in Spacer
162	1	.750 x .134 x 1.255 DOM Sleeve
65	3	.750 x .134 x 1.650 Rolled Sleeve
163	1	.8125 x .120 x 1.620 DOM Sleeve - Tbar Brkt
03326	4	Alignment Cam
A356	1	Adjustable Front Track Bar

## 014330 Box Kit Bolt Packs

Part #	Qty	Description
758	1	Bolt Pack - Rear Sway Bar Links
	2	12mm-1.75 x 60mm bolt
	2	12mm-1.75 prevailing torque nut
	4	1/2" SAE washer
843	1	Bolt Pack - Front Bump Stops
	2	3/8"-16 x 3-3/4" bolt
	2	3/8" SAE flat washer
	2	3/8"-16 Serrated edge flanged nut
835	1	Bolt Pack - Track Bar Bracket/Rear
	2	9/16"-12 x 3-1/4" bolt
	2	9/16"-12 prevailing torque nut
	4	9/16" SAE flat washer
	2	7/16"-14 x 1-1/4" hex bolt
	2	7/16" prevailing torque nut
	4	7/16" SAE flat washer
	1	1/4"-20 x 3/4" hex bolt
1	1/4"-20 prevailing torque nut	
839	2	1/4" SAE flat washer
	1	Cable clamp
	1	Bolt Pack - Rear Bump Stops
	4	5/16"-18 x 3/4" grade 5 bolt
J127	4	5/16"-18 prevailing torque nut
	8	5/16" SAE washer
	1	Bolt Pack - Front sway bar disconnects
	2	12mm-1.75 x 75mm bolt grade 10.9 - clear zinc
	2	12mm-1.75 x 75mm prevailing torque nut - clear zinc
	4	12mm flat washer - clear zinc
	2	5/16"-18 x 3/4" bolt grade 5 - clear zinc
	2	5/16"-18 prevailing torque nut - clear zinc
4	5/16" SAE flat washer - clear zinc	
J172	1	Bolt Pack - 2024 JL 14mm Sway Bar Link
	2	14mm-2.00 x 80mm Bolt - Class 8.8
	2	14mm-2.00 Prevailing Torque Nut
	4	14mm Flat Washer - Clear Zinc
149	2	.750 x 0.095 x 1.680 DOM Sleeve

# INSTALLATION INSTRUCTIONS

## INSTALLATION INSTRUCTIONS

1. Park the vehicle on a clean, flat surface and block the rear wheels for safety.
2. Measure from the center of the wheel up to the bottom edge of the wheel opening

LF \_\_\_\_\_ RF \_\_\_\_\_ LR \_\_\_\_\_ RR \_\_\_\_\_

3. Disconnect the front track bar from the axle. Retain mounting bolt. (Fig 1)

## SPECIAL TOOLS

Rotary grinder or carbide burr for cam slot removal

**FIGURE 1**

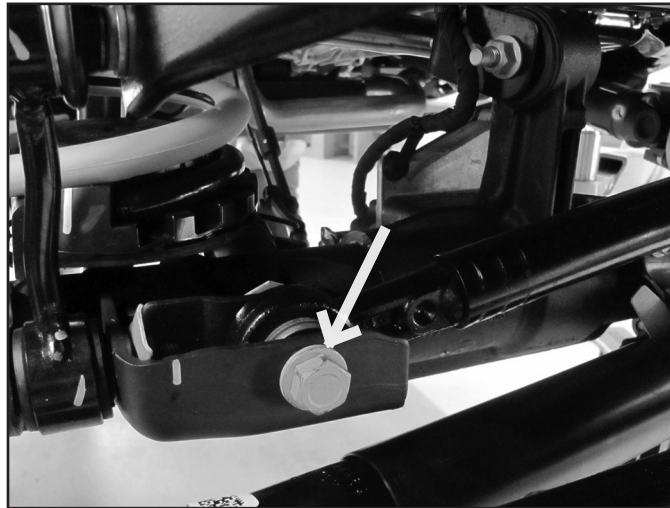

4. Disconnect front track bar from frame and remove from vehicle. Retain mounting bolt.
5. Raise the front of the vehicle and support the frame with jack stands behind the front lower control arm pockets.
6. Remove the wheels.
7. Disconnect the central axle disconnect (CAD) from the front axle as well as the two clip holding it to the axle. Rubicon models, disconnect the locker wire harness from the axle (Fig 2)

**FIGURE 2**

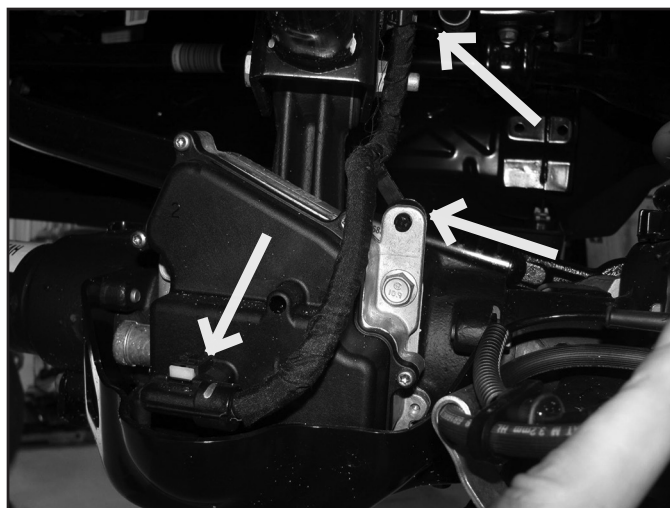

8. Disconnect the OE front sway bar links from the sway bar and the axle (Fig 3). Save lower hardware.

**FIGURE 3**



9. Disconnect the brake lines from the control arms to allow enough slack for coil removal (Fig 4). Support the front axle with a hydraulic jack. Remove the front shocks from the vehicle. Retain upper and lower mounting hardware.

**FIGURE 4**

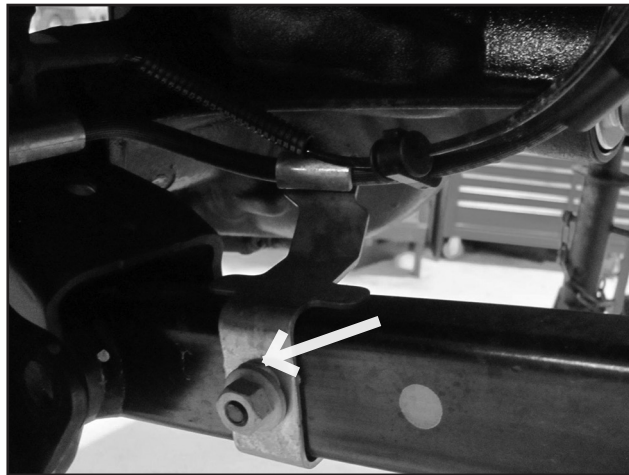

10. Disconnect the front driveshaft at the axle flange by removing the 4 bolts.
11. Lower the front axle and remove the coil springs from the vehicle. Use care not to over extend the brake lines, or driveshaft.
12. Place a provided bump stop extension inside one of the new front coil springs and install the spring in the vehicle. Rotate the spring until it is seated properly in the axle mount.
13. Attach the bump stop extension to the axle through the hole using a 3/8" x 3-3/4" bolt, nut, and 3/8" USS washers (BP 843). Torque bolt to 29 ft-lbs. Repeat the spring/bump stop installation of the other side of the vehicle.



**Tip** *On the passenger side it may be easiest to remove the brake line bracket from behind the coil mount to gain better access to get the nut started on the bolt for the bump stop.*

14. Install the hourglass bushings in the shocks. Shorter ones for the front with the shorter sleeve on the lower mount and the longer sleeve and nylon spacers on each side of the upper mount. Fox shocks install with the body up, NX<sup>2</sup> shocks install with the body down. Using the factory hardware, torque the upper bolt to 81 ft-lbs and the lower bolt to 74 ft-lbs.
15. Adjust both quicker disconnects to approximately 9" (measured eye to eye) and tighten the jam nuts. Insert the longer sleeves into the upper bushing (male end) and slide the polyurethane spacer onto the upper sleeve so it will mount towards the swaybar. The links will be installed with the grease fittings forward. (BP J127)

**IMPORTANT: Bushing cradles at both ends of quicker disconnect must remain parallel with each other when Jam Nut is tightened.**

16. 2024 Models: Use the larger ID sleeves that will accommodate 14mm hardware
17. Using the provided 12mm x 75mm bolts, washers, and nuts loosely fasten the sway bar links to the sway bar with the bolts going from the outside towards the frame (Fig 5).
18. 2024 Models: Use the larger 14mm hardware found in bolt pack J172

**FIGURE 5**

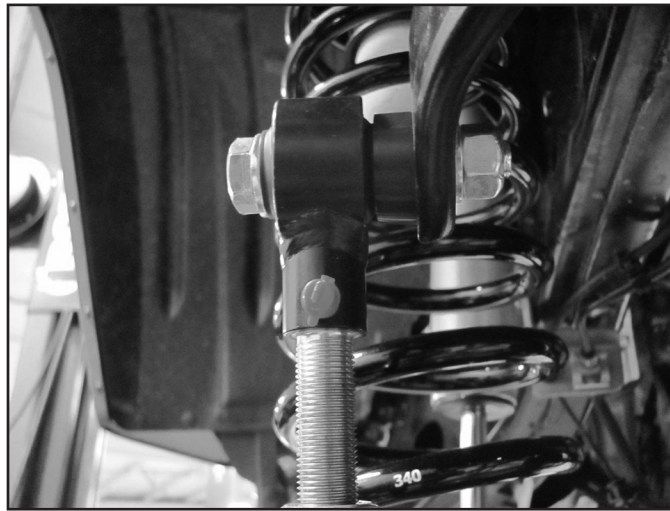

*Rubicon models have a factory electronic disconnect system. Follow these steps 16-21 to solid mount your sway bar links.*

19. Set the sway bar into disconnect mode for ease of installation of the links to the axle.
20. Locate the 1-1/4" sleeve and insert it into the passenger side disconnect bushing.
21. Insert the 1/4" thick spacer and disconnect into the original sway bar link location. It may be necessary to slightly open up the link opening for ease of assembly.
22. Fasten the link to the axle with the original hardware. Adjust the length as necessary to ensure the links do not bind at full droop, depending on the shocks being installed. (Fig 6)

**FIGURE 6**



23. Install the remaining longer sleeve on the driver side and slide the polyurethane spacer onto the sleeve so it will mount towards the axle mount tab. Install the quicker disconnect to the inboard side of the axle tab with the original sway bar link hardware.

*Note: If the link length was adjusted for the passenger side, match the length on the driver side link.*

24. Torque the upper and lower hardware to 65 ft-lbs

**Non-Rubicon models follow steps 22-26**

25. Non-Rubicon Models Only: Measure back 1-1/4" from the center of the sway bar link hole or just past the weld at the axle and make a vertical cut line. Cut off the tab at the mark and paint exposed metal. (Fig 7)

**FIGURE 7**

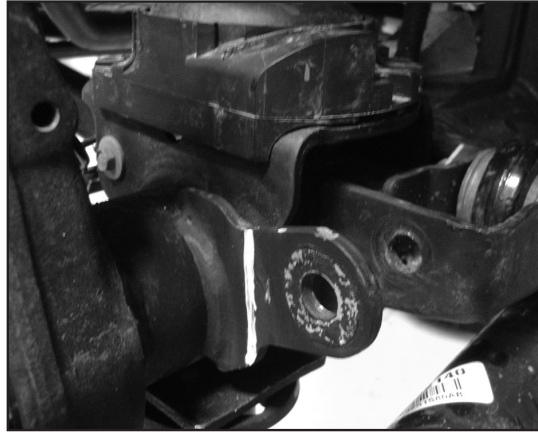

26. Attach the short mounting post into the original sway bar link mount hole on the track bar bracket. Tighten the post ensuring the click pin hole is horizontal or parallel with the ground. Tighten to 65 ft-lbs. (Fig 8)

*Note: A small screwdriver or punch inserted into the pin hole will keep the post from turning as you tighten it.*

**FIGURE 8**



27. Attach the long mounting post with polyurethane spacer into the factory sway bar link mount. The stud should point towards the center of the vehicle. Tighten the post ensuring the click pin hole is horizontal or parallel with the ground. Tighten to 65 ft-lbs. (Fig 9)

**FIGURE 9**

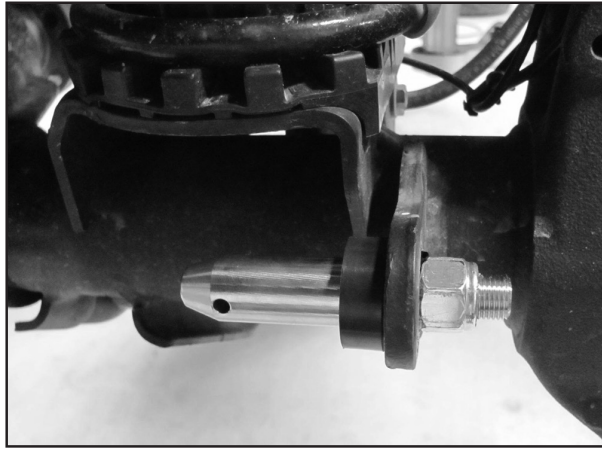

- 28. Torque the quicker disconnect to sway bar mounting bolts to 65 ft-lbs.
- 29. Insert click pins as illustrated to secure.

**CORRECT**

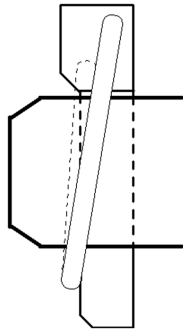

**WRONG**

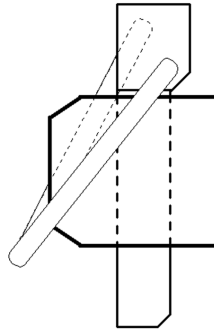

*When properly installed, the ring on the Click Pin will "snap" against the shaft of pin. When installed backwards, the ring does not fit snugly against shaft.*

**All Models**

- 30. Install the retention brackets using the provided 5/16" bolts (BP J127) into the factory hole in the front of the coil bucket as shown. These are designed to slightly form to the edge of the coil bucket to hold them in place. (Fig 10)

**FIGURE 10**



- 31. With the front axle still support with a jack, remove the driver's side lower control arm bolt at the axle. The OE lower control arm mounts designed for alignment cams. The section behind the bolt must be removed to use the cam washers supplied in this kit. Special tools are made to perform this operation but are not necessary. The perforated sections can be removed most easily with a carbide burr or rotary grinding tool. Only the rear portion of the cam slot must be removed (Fig 11).



**FIGURE 11**

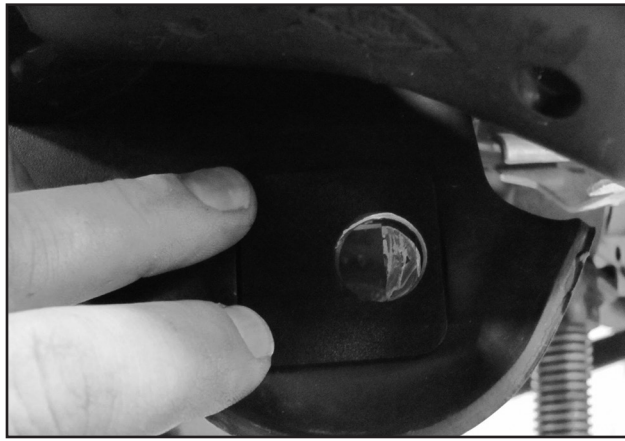

32. When the perforated sections are removed from the lower control arm mount, reinstall the control arm to the axle with cams on factory bolt. Rotate the cams so that the bolt is as far towards the 'rear' of the slot as possible. Just snug the cam hardware so that the cam washers are retained within the stops. Final cam bolt torque will be completed with the weight of the vehicle on the suspension. (Fig 12)

**FIGURE 12**



**Tip**

- Caution**
33. Repeat cam washer installation on the passenger side.
34. Reattach the brake lines to the control arms, and any axle wire harness disconnected during the install.
35. Re-install front driveshaft with the 4 OE bolts and threadlocker. Torque to 89 ft-lbs.
36. Install the wheels and torque lug nuts to 130 ft-lbs.
37. Lower the vehicle to the ground and bounce the front to settle the suspension. Torque the front control arm bolts to 103 ft-lbs plus 145 degrees.
38. Front track bar installation: Thread the hex adjustment collar all the way in, then thread out the axle end one turn. Adjust the eye to eye length of the track bar to 34" using the adjustment collar. Ensure the bushings are not spinning.
39. Install the new track bar on the vehicle, installing frame side first. Ensure the gusset plate on the axle side is on top.

*The preferred method to aligning the axle side bolt is to have an assistant turn the steering wheel in small increments to shift the chassis. If working by yourself, a ratchet strap can be used.*

40. The length of the track bar can be adjusted while installed by turning the hex adjustment collar. If necessary, a 1-1/2" wrench or accessory BDS129601 can be used. Make adjustments as necessary to center the axle from side to side.

*In order to ensure proper thread engagement, do not extend the axle side bushing past 6", and do not extend the hex adjustment collar past 1-7/8". Reference figure 13 below.*

**FIGURE 13**

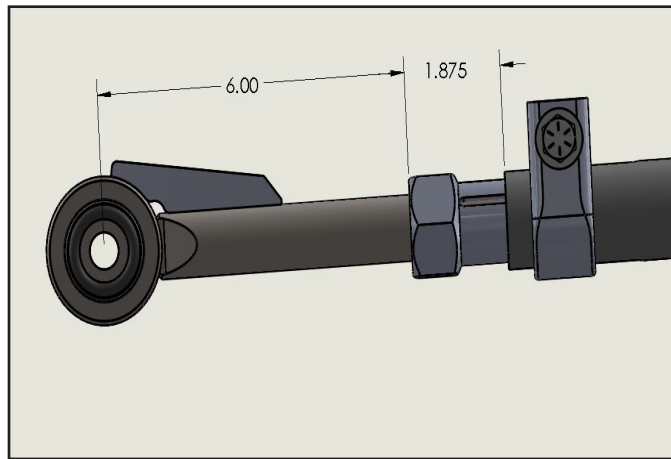

41. Ensure that the clamp is located 1/2" from the end of the tube, facing up. This is to avoid contact with other suspension/ steering components. Also ensure that the clamp is centered upon the slit on the end of the tube. Both the slit on the tube and the slit on the hex adjustment collar must be perfectly aligned in order to ensure adequate clamping force. This is illustrated in figure 14 below.

**FIGURE 14**

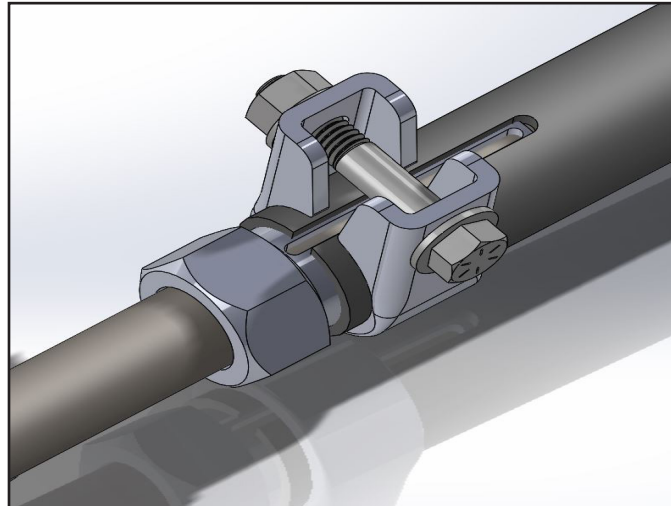

42. Using a 5/8" socket and 11/16" wrench, tighten the pinch bolt to 40 ft-lbs.
43. Tighten trackbar mounting hardware to the proper torque specifications, 52 ft-lbs plus 115 degrees on the frame end and 52 ft-lbs plus 155 degrees on the axle end.
44. Recheck all hardware, check again at regular maintenance intervals.

## REAR INSTALLATION

1. Block the front wheels for safety.
2. Disconnect the rear track bar from the axle. Retain hardware.
3. Raise the rear of the vehicle and support the frame with jack stands in front of the lower control arm mounts. Remove the tires.
4. Rubicon models, disconnect the locker wire harness from the differential.
5. Disconnect the brake line brackets from the axle, save hardware. (Fig 1)

**FIGURE 1**

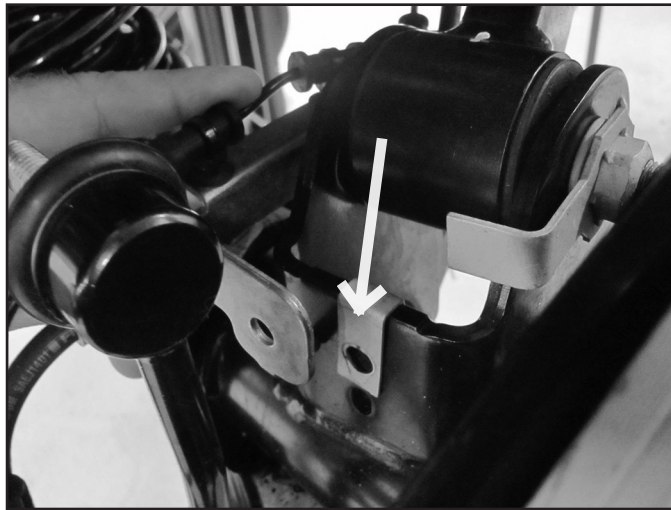

6. Remove the two bolts holding the TPMS ECU to the rear crossmember. Relocate the sensor to the passenger side upper coil mount using the provided 1/4" hardware. (BP 835) (Fig 2,3)

**FIGURE 2**

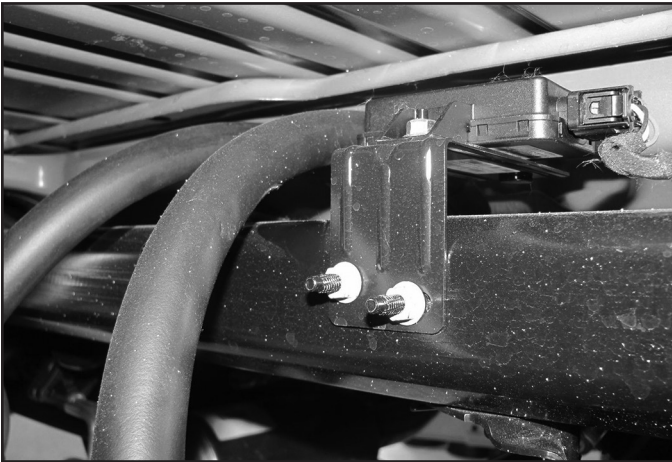

**FIGURE 3**

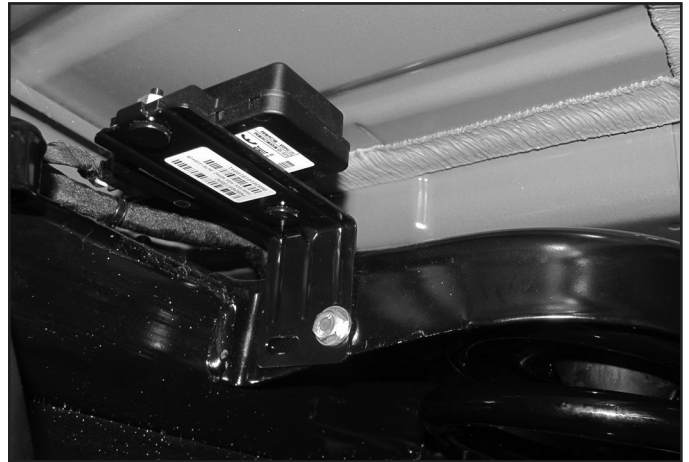

7. Remove the rear fender covers to gain access to the rear upper shock mounts by removing the 3 mounting screws. (Fig 4)

**FIGURE 4**



8. Support the axle with a hydraulic jack and remove the shocks. Retain the upper and lower mounting hardware.
9. Disconnect the rear sway bar links from the frame and axle. Retain hardware. (Fig 5)

**FIGURE 5**

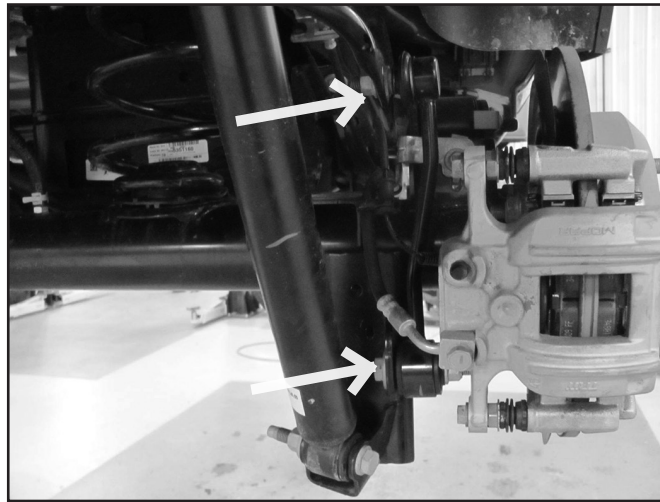

10. Lower the axle and remove the rear springs, take note of the upper spring mount orientation. There is a nipple on the coil isolator that lines up with a hole in the frame.



**Tip** Do not overextend the brakelines or ABS wires. It may be necessary to remove these from their retaining clips temporarily.

11. Install the new rear springs in the vehicle, making sure the OE upper rubber isolator is in place. Raise the axle to slightly compress the spring.
12. Install the hourglass bushings and sleeves into the provided rear sway bar links. Install the sway bar links using the factory axle hardware and provided 12mm hardware at the sway bar (BP 758). The links should be installed so the links offset in towards the axle from the sway bar. Torque hardware to 40 ft-lbs. (Fig 6)

**FIGURE 6**



13. Raise the axle with a jack enough to install the new shocks with the factory hardware. The Nitro shocks will be installed body down, Fox shocks install with the body up. Use the supplied longer sleeve nylon spacers on each side of the bushing on the upper mount and the shorter sleeve at the axle. Torque the upper bolt to 81 ft-lbs and the lower bolt to 74 ft-lbs.
14. Install the cable clamp around the passenger side parking brake cable and fasten to the stud that used to hold the TPMS ECU using the factory nut. (BP 839) (Fig 7)

**FIGURE 7**



15. Install the provided bump stop spacers on the axle using the existing holes in the axle bump stop pad. Fasten the bump stop spacer to the axle with 5/16" bolts, nuts, and washers (BP 839). Torque bolts to 20 ft-lbs. (Fig 8)

**FIGURE 8**



16. Locate the rear track bar bracket and temporarily install it into the OE axle bracket with the new provided 9/16" hardware. (BP839) The bracket mounts to the back and outside faces of the OE mount (Fig 9).
17. Using the bracket as a template, mark the outside holes to be drilled. Remove the bracket and drill 1/2" holes at the mark.

**FIGURE 9**



18. Reinstall the track bar bracket with the 9/16" hardware (BP 839) along with the provided crush sleeve (163) inside the factory mount and the Supporting bracket (03580) on the frontside of the OE mount. Run the bolt through the new bracket, OE mount, sleeve, and supporting bracket (Fig 10). Leave hardware loose.

**FIGURE 10**

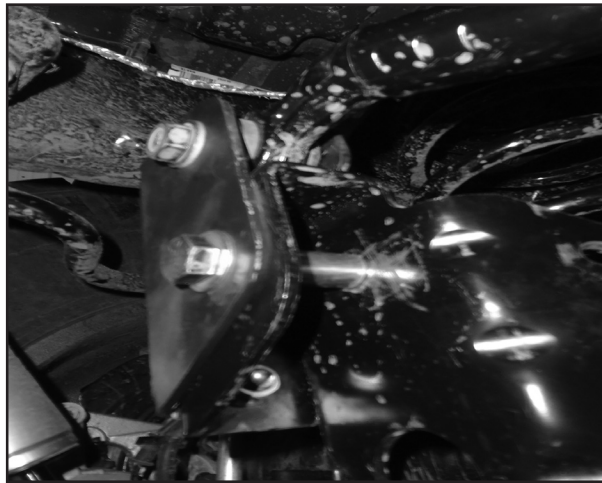

19. Fasten the new brackets to the frame through the outer holes using the provided 7/16" hardware. Torque the 7/16" hardware to 59 ft-lbs. Torque the 9/16" bolt in the OE location to 130 ft-lbs. (Fig 11)

**FIGURE 11**



20. Reinstall the rearmost fender liner.
21. Reinstall wheels and torque to factory specifications. Lower vehicle to ground.
22. Install the rear track bar into the new relocation bracket with the new 9/16" track bar hardware. An assistant may be needed to push on the body of the vehicle to help align the track bar in the bracket.
23. With the track bar installed, torque the 9/16" bolt to 130 ft-lbs.
24. Double check all hardware for proper torque.
25. Lubricate all grease zerker fittings on the Quicker Disconnects using common wheel bearing grease or equivalent.
26. Check all fasteners after 500 miles and at regularly scheduled maintenance intervals.

<b>Component</b>	<b>Torque (FT-LBS)</b>
Front Bump Stop	29
Upper Shock Hardware	81
Lower Shock Hardware	74
Front Sway Bar Link Bolts	65
Front Quick disconnect Post	65
Front Driveshaft Flange	89
Lug Nuts	130
Front Lower Control Arm	103 plus 145 degrees
Front Track Bar Pinch Bolt	40
Front Track Bar at Frame	52 plus 115 degrees
Front Track Bar at Axle	52 plus 155 degrees
Rear Sway Bar Links	60
Rear Upper Shock Hardware	81
Rear Lower Shock Hardware	74
Rear Track Bar Bracket- 7/16"	59
Rear Track Bar Bracket- 9/16"	130



## **WE WANT TO SEE YOUR RIDE!**

Grab photos of your BDS-equipped truck in action and send them in for a chance to be featured. Send it in to our Bad Ass Rides customer gallery at [bds-suspension.com/bar](http://bds-suspension.com/bar) and post them on the BDS Fan Page on Facebook at [facebook.com/BDSSuspensions](https://facebook.com/BDSSuspensions). Don't forget about your BDS swag! BDS offers t-shirts, hoodies, decals and more available on the BDS website or through your local BDS distributor.

---

## **TIME TO HAVE SOME FUN**

**Thank you for choosing BDS Suspension.**

For questions, technical support and warranty issues relating to this BDS Suspension product, please contact your distributor/installer before contacting BDS Suspension directly.